

Installation and Operating Instructions

POOLcontrol®-40.NET

CE

Filter control unit with built-in level control and LAN port

Part no. 310.000.0565



Technical data

Dimensions:	325mm x 281mm x 168mm	
Operating voltage:	400V/50Hz	
Power consumption of control unit:	approx. 5VA (depends on operating mode)	
Switching capacity:	Pump:	max. 8A / 3.0 kW (AC3)
	Heating:	max. 3A / 0.4 kW (AC3)
	Dosing system:	max. 3A / 0.4 kW (AC3)
	Auxiliary output:	max. 3A / 0.4 kW (AC3)
Degree of protection:	IP 40	
Level sensors:	Safety Extra Low Voltage (SELV)	
Ambient temperature:	0-40°C	
Air humidity:	0-95% non-condensing	

Contents

Installation and Operating Instructions	1
Technical data.....	1
Contents	2
Function.....	5
Installation.....	5
Electrical connection.....	5
Low-voltage lines	6
Connecting the power supply for a 400V three-phase pump	6
Connecting the power supply for a 230V single-phase AC pump	6
Connecting the power supply for a 230V pump (with electronic motor protection enabled).....	7
Connecting the power supply for a Speck ECO-Touch-Pro pump	7
Connecting the power supply for a Speck ECO-VS pump	7
Connecting the power supply for a Speck ECO-Motion pump	7
Connecting the power supply for a Zodiac FloPro VS pump.....	8
Connecting the power supply for a Pentair IntelliFlo pump	8
Connecting the power supply for a Pentair SuperFlo VS pump	8
Connecting the heating.....	9
Connecting the EUROTRONIK-10 for backwashing using a 6-way multiport valve.....	9
Operating the PC-40 without a EUROTRONIK-10 unit	9
Connecting the slide valves for backwashing.....	9
Connecting underwater lighting, flocculation pump, dispensing equipment.....	9
Connecting a main drain valve (ECO valve).....	10
Connecting a fault indicator	10
Connecting a flow sensor	10
Connecting a pressure switch	10
Connecting a cover limit-switch	11
Level control	11
Overflow pools with spillway	11
Use with outdoor pools.....	11
How level control works for balancing tanks	12
Pools with skimmer	12
Use without level control.....	13
Solenoid valve for topping up the water level	13
Temperature sensor	13
Pool temperature sensor	13
Solar temperature sensor.....	14
Air temperature sensor	14
Fuses	14

Controls on the front panel.....	15
LCD	15
LCD	15
LCD	15
Control unit ON/OFF.....	15
Manual operation.....	16
Reset fault indicator.....	16
ECO ON/OFF	16
Pump indicator light.....	16
Heating indicator light	16
Solar heating indicator light	16
Adjustment buttons.....	16
Temperature selection.....	16
Setting the time.....	16
Timer programming.....	17
Changing the timer settings.....	17
Clearing the timer settings.....	17
Configuration menu.....	18
Filter pump.....	18
Type	18
Motor current.....	18
Motor protection	18
Startup time.....	18
ECO mode.....	19
Timer	19
Temperature reduction.....	19
Heating	19
Operating mode.....	19
Priority	19
Minimum switching interval	19
Over-run time	19
Temperature limit	19
Solar heating.....	20
Operating mode.....	20
Priority	20
Minimum switching interval	20
Switch-on difference.....	20
Switch-off difference.....	20
Temperature boost.....	20
Pump speed	20
Frost protection.....	21
Operating mode.....	21
Air temperature.....	21
Water temperature	21
Backwashing	21
Operating mode.....	21
Timer	21
Stop backwashing.....	21
Backwash period.....	21
Rinse period	21
Valve delay	22
Fortnightly.....	22
Use main drain	22

Level control	22
Type	22
Time limit	22
Minimum switching interval	22
Auxiliary output	23
Operating mode.....	23
Timer	23
Cycle time.....	23
ON period	23
Interlock.....	23
Network (LAN)	23
IP address	23
Device ID.....	23
User PIN.....	23
Service PIN	24
Sensor calibration.....	24
Water temperature	24
Solar temperature.....	24
Air temperature.....	24
Language.....	24
Language selection	24
Internet connection	25
Using the osf communications server	25
Operating the unit via the web server	26
Home page	27
Icons in the status bar	27
Icons in the control bar.....	27
User login	27
System information page.....	27
Information page.....	28
Main menu.....	28
Pool settings	28
Heating settings	28
Temperature setpoint	28
Frost protection function.....	28
Settings for the filter installation.....	29
Settings for the auxiliary output	29
Settings for ECO mode.....	29
Settings for the service engineer	29
Operating statistics.....	29
Network settings.....	30
Hardware configuration	30
Interfacing with building automation systems.....	31
Menu structure	34

Function

The **osi** PC-40.net control unit lets you time the on/off cycles of a filter pump based on a user-programmable daily or weekly schedule. A 400V 3-phase pump, a 230V single-phase AC pump or a variable-speed filter pump may be used as the filter pump (see wiring diagrams). When using a 3-phase filter pump, a 3-phase electronic motor protection device protects the pump from overload (current range has continuous adjustment up to 8A).

Backwashing can be performed using a 6-way multiport valve and installed EUROTRONIK-10 controller or using slide valves under manual, timed or pressure-dependent control.

The built-in level control is designed for use with overflow pools with spillway (balancing tank) and for skimmer pools.

While the filter pump is running, the swimming pool heating is controlled by the electronic temperature controller. During pauses in filtration, the heating is automatically switched off by the internal interlock. The required water temperature for the swimming pool can be set on the front panel. The heating can also be switched off from here. A live contact (terminal U2) and volt-free floating contacts (terminals 17&18) are available for connecting the heating system. Terminals are provided for connecting an **osi** solar actuator when operating solar absorbers that carry a direct flow of water from the pool. This control unit is not intended for use with other types of solar collectors. The absorber temperature must not exceed 80°C at the temperature sensor.

Terminals for connecting level sensors can be used for convenient automatic control of the water level in the swimming pool. There are also terminals for connecting a flow sensor or a pressure switch, and a winding thermostat contact. These provide extra protection for the filter pump against potential damage from dry-running of the filter installation.

Spare terminals are available for connecting additional devices such as underwater lights and chemical dosing equipment. A load (230V/max. 3A) connected to terminal U4 (auxiliary output) can be timed to switch on and off by its own dedicated timer in the unit. Terminal U3 (dosing equipment) carries 230 V only while filtration is running, but is de-energized outside filtration times. Terminals 15&16 (dosing equipment) are volt-free floating contacts for custom use. The relay contact between terminals 15 and 16 is closed while filtration is running, and open outside filtration times. This contact is rated for a maximum voltage of 230V and a maximum power of 400W ($\cos \varphi=0.6$).

Terminals 19&20 are volt-free floating contacts that can be used for fault indication.

The connecting terminals for the winding protection switch (WSK terminals) can be used to connect a winding thermostat built into the filter-pump motor winding. If this thermal switch opens, e.g. as a result of the motor winding getting too hot, the filter pump is switched off automatically along with the heating and dosing equipment. Once the winding protection switch closes again after the motor winding has cooled down, the units automatically switch back on. There is no need for a manual reset. The connecting terminals for the winding protection switch carry 230V.

The motor protection device can only be used with 400V/50Hz filter pumps connected to terminals U1/V1/W1. Motor protection is not active if you have selected a configuration using a variable speed pump or a 230V pump.

Installation

The swimming pool must be designed to prevent consequential damage resulting from a potential technical fault, power failure or faulty controller.

Electrical connection

The control unit must be mounted such that it is protected from moisture in accordance with its degree of protection. The ambient temperature must lie between 0°C and + 40°C and should vary as little as possible. The relative humidity at the installation position must not exceed 95% and there must not be any condensation. Avoid exposing the unit to direct heat or sunlight.

The power supply for the unit must be provided via an all-pole disconnection switch with a minimum contact gap of 3mm and via a residual-current circuit breaker with a fault current I_{FN} of $\leq 30\text{mA}$. When using variable-frequency drives and variable speed pumps, the residual-current circuit breakers stipulated for these devices

must be used and the relevant regulations observed. **Always disconnect the unit from the power supply before opening the case. All electrical wiring and calibration and servicing work must be performed solely by an approved electrician. The enclosed wiring diagrams and all applicable safety regulations must be observed.**

The switching outputs of the PC-40 are not intended as a voltage supply for variable frequency drives. Please refer to the relevant wiring diagrams in these operating instructions.

Low-voltage lines

Low-voltage lines must not be laid along with three-phase or AC power cables in the same cable conduit. In general, always avoid routing low-voltage lines close to three-phase or AC power cables.

Connecting the power supply for a 400V three-phase pump

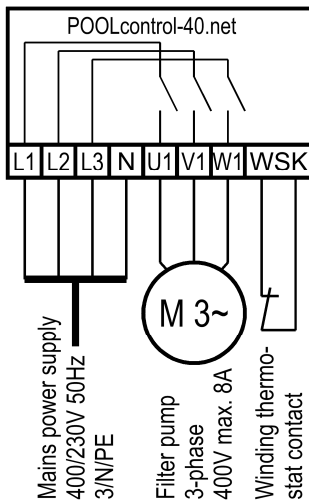

The factory-inserted link between the two WSK terminals must be removed when connecting a pump fitted with a thermal winding protection switch (winding thermostat). If the pump does not have a winding protection switch, the link must remain screwed in place. These terminals are live and carry a mains voltage!

The option **Filter pump - type: 3-phase pump** must be selected for the filter pump in the configuration menu.

The pump is monitored by the electronic motor protection device. To provide protection, the trip current for the motor protector must be set to the rated current of the pump (specified on the type plate).

Connecting the power supply for a 230V single-phase AC pump

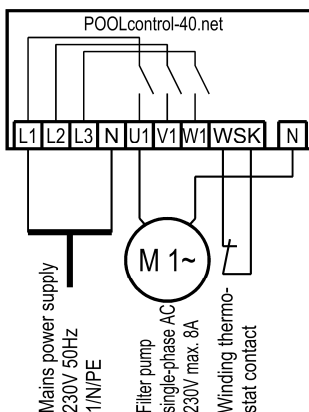

The factory-inserted link between the two WSK terminals must be removed when connecting a pump fitted with a thermal winding protection switch (winding thermostat). If the pump does not have a winding protection switch, the link must remain screwed in place. These terminals are live and carry a mains voltage!

The option **Filter pump - type: monophase pump** must be selected for the filter pump in the configuration menu.

In this operating mode, the pump is not monitored by the electronic motor protection device.

Connecting the power supply for a 230V pump (with electronic motor protection enabled)

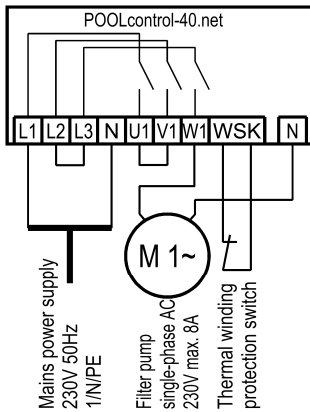

If a 230V pump is meant to be monitored by the electronic motor protection device, the option **Filter pump - type: 3-phase pump** must be selected for the filter pump. The trip current for the motor protector must be set to the rated current of the pump (specified on the type plate). For the electronic motor protection to work correctly, the electrical power to the motor must pass via all three switching contacts of the filter control unit (place link between terminals L2 and L2 and between U1 and V1; connect pump to W1).

The factory-inserted link between the two WSK terminals must be removed when connecting a pump fitted with a thermal winding protection switch (winding thermostat). If the pump does not have a winding protection switch, the link must remain screwed in place. These terminals are live and carry a mains voltage!

Connecting the power supply for a Speck ECO-Touch-Pro pump

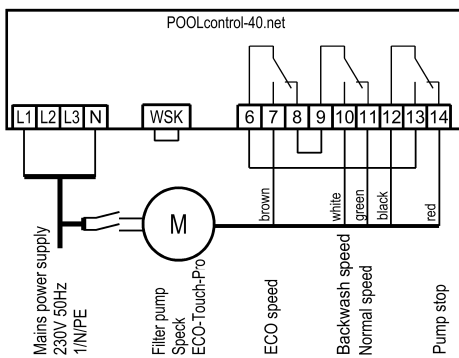

A Speck ECO-Touch-Pro pump can be connected directly to the PC-40 unit. Connect the speed controller to terminals 6-14.

A separate mains power supply must be provided for the pump. The power supply cannot be provided by the PC-40.

There must be a link inserted between the two WSK terminals (winding protection switch).

The option **Filter pump - type: var. speed pump** must be selected for the filter pump in the configuration menu.

Always refer to the operating instructions for the pump.

Connecting the power supply for a Speck ECO-VS pump

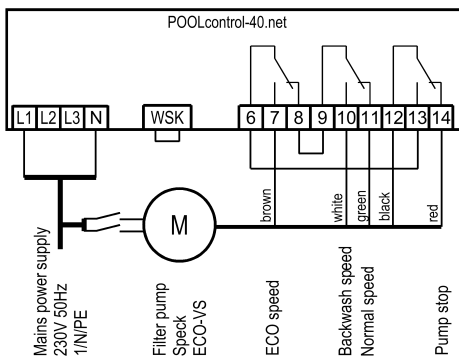

A Speck ECO-VS pump can be connected directly to the PC-40 unit. Connect the speed controller to terminals 6-14.

A separate mains power supply must be provided for the pump. The power supply cannot be provided by the PC-40.

There must be a link inserted between the two WSK terminals (winding protection switch).

The option **Filter pump - type: var. speed pump** must be selected for the filter pump in the configuration menu.

Always refer to the operating instructions for the pump.

The digital inputs must be set at the pump to "dl" in the pump setup menu.

Connecting the power supply for a Speck ECO-Motion pump

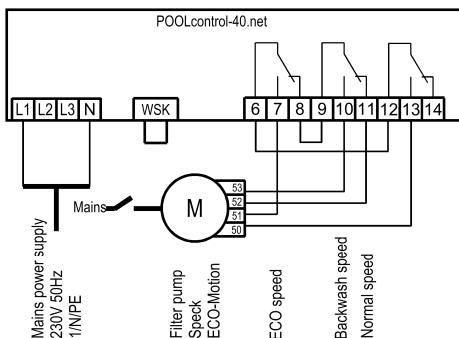

A Speck ECO-Motion pump can be connected directly to the PC-40 unit. Connect the speed controller to terminals 6-13.

A separate mains power supply must be provided for the pump. The power supply cannot be provided by the PC-40.

There must be a link inserted between the two WSK terminals (winding protection switch).

The option **Filter pump - type: var. speed pump** must be selected for the filter pump in the configuration menu.

Always refer to the operating instructions for the pump.

In the Setup menu on the pump, the external control must be enabled for "digital fixed speeds" with the signal type "continuous signal". The speeds required for ECO mode, normal mode and backwash mode

must be set for the speeds N1, N2 and N3.

Connecting the power supply for a Zodiac FloPro VS pump

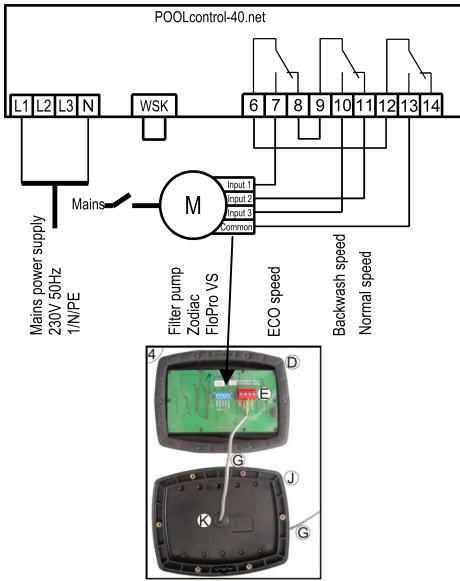

A Zodiac FloPro VS pump can be connected directly to the PC-40 unit. Connect the speed controller to terminals 6-13.

A separate mains power supply must be provided for the pump. The power supply cannot be provided by the PC-40.

There must be a link inserted between the two WSK terminals (winding protection switch).

The option **Filter pump - type: var. speed pump** must be selected for the filter pump in the configuration menu.

Always refer to the operating instructions for the pump.

At the pump, the speed controller must be connected to the designated terminals on the back of the user interface. The speeds required for ECO mode (level 1), normal mode (level 2) and backwash mode (level 3) must be assigned to speed levels 1 to 3.

Connecting the power supply for a Pentair IntelliFlo pump

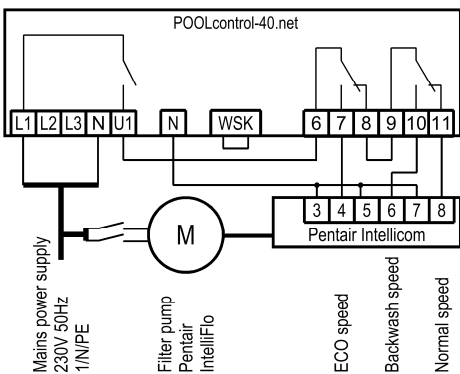

An IntelliFlo pump can be controlled by the PC-40 using the Pentair Intellicom controller.

A separate mains power supply must be provided for the pump. The power supply cannot be provided by the PC-40.

There must be a link inserted between the two WSK terminals (winding protection switch).

The option **Filter pump - type: var. speed pump** must be selected for the filter pump in the configuration menu.

Always refer to the operating instructions for the pump.

Connecting the power supply for a Pentair SuperFlo VS pump

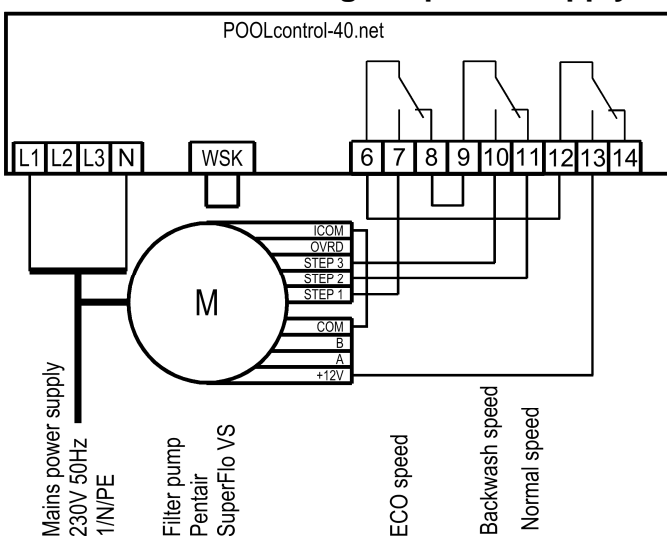

A SuperFlo VS pump can be controlled by the PC-40 unit.

A separate mains power supply must be provided for the pump. The power supply cannot be provided by the PC-40.

There must be a link inserted between the two WSK terminals (winding protection switch).

The option **Filter pump - type: var. speed pump** must be selected for the filter pump in the configuration menu.

Always refer to the operating instructions for the pump.

Connecting the heating

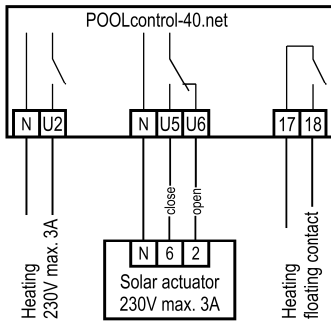

The pool heating can be connected to the terminal U2. This output supplies 230V and is rated for a maximum load of 3A.

In addition, a volt-free floating contact is provided at terminals 17&18 (e.g. for controlling the boiler).

An **tsi** 230V solar actuator can be connected to terminals U5 and U6 for operating the solar heating. When solar heating is operating, the mains voltage is applied to terminal U6 and no voltage is applied to terminal U5. When solar heating is not actuated, no voltage is applied to terminal U6 and the mains voltage appears at terminal U5.

Connecting the EUROTRONIK-10 for backwashing using a 6-way multiport valve

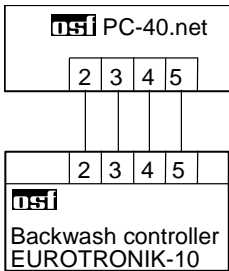

A 4-wire connection is required for connecting the EUROTRONIK-10. The wires must not be swapped over, i.e. they must be connected to the same terminal at each end. The EUROTRONIK-10 additionally requires a separate power supply.

Operating the PC-40 without a EUROTRONIK-10 unit

If the PC-40 is intended to be operated without a EUROTRONIK-10 unit, terminals 3 and 5 must be connected together (with a link). Disconnect the connecting cable before doing so.

Connecting the slide valves for backwashing

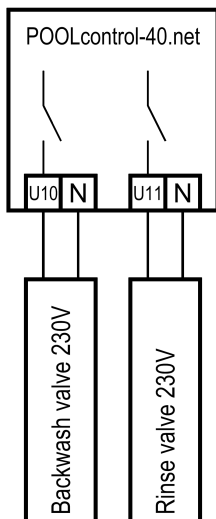

A 230V slide valve for the backwash function can be connected to the terminals U10 and N.

A 230V slide valve for the rinsing function can be connected to the terminals U11 and N.

Both valves are controlled by the internal backwash controller.

The heating and dosing systems are disabled during the backwash and rinsing operation.

Connecting underwater lighting, flocculation pump, dispensing equipment

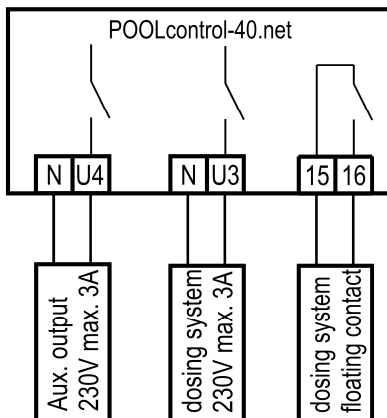

An auxiliary item of equipment running at 230V (e.g. underwater lighting) can be connected to terminal U4 and can then be timed to switch on and off by a dedicated timer in the control unit. Since this is a configurable output, it can also be used for controlling a flocculation pump.

An auxiliary item of equipment running at 230V (e.g. dosing equipment) can be connected to terminal U3. This equipment is switched on together with the filter pump during filtration.

A volt-free floating relay contact is connected between terminals 15 and 16 inside the control unit. This can be used to control additional dosing equipment (contact is closed during filtration).

This contact is rated for a maximum load of 230V/4A.

Connecting a main drain valve (ECO valve)

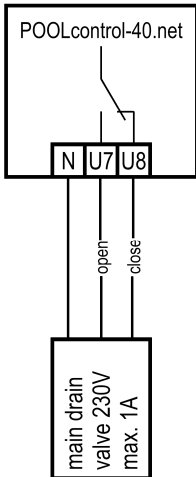

A main drain valve (ECO valve) or a valve for water extraction from the pool walls can be connected to terminals U7 and U8. Connect a 2-way valve to terminal U7 and neutral terminal N. For a 3-way valve, use terminal U7 for "OPEN" and terminal U8 for "CLOSE". This contact is rated for a maximum load of 230V/1A.

For overflow pools with spillway, this valve is opened in ECO mode to minimize evaporation losses.

If this valve is also meant to be opened during backwashing, then the option **Backwashing - floor drain: valve open in BW** must be selected in the configuration menu.

Connecting a fault indicator

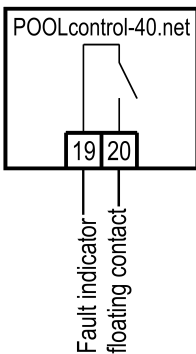

An external fault indicator can be connected to volt-free floating terminals 19 and 20. This contact is rated for a maximum load of 230V/4A.

Connecting a flow sensor

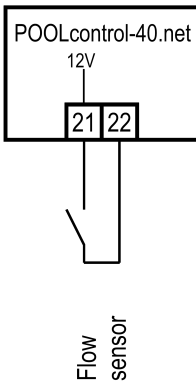

A flow sensor or a pressure sensor can be connected between terminals 21 and 22 instead of the factory-fitted link, to provide additional protection for the pump against dry-running. During filtration, a certain maximum time (factory set to 10 seconds, adjustment range 5-60 sec) is allowed after the filter pump starts running before this contact must close. If the contacts do not close in this time, the filter pump is switched off and the fault indicator light comes on. This contact is not polled during backwashing.

The terminals carry a safety extra low voltage.

Connecting a pressure switch

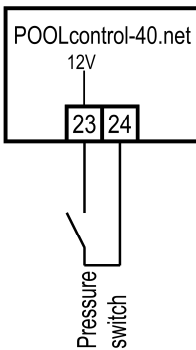

A pressure switch fitted in the pressure line or in the gauge port of the central valve can be connected to terminals 23 and 24. The backwash process starts if the floating contact of the pressure switch is closed for at least 10 seconds.

The terminals carry a safety extra low voltage.

Connecting a cover limit-switch

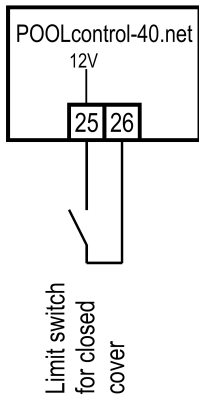

A limit switch for the swimming-pool cover can be connected to terminals 25 and 26. This switch automatically starts ECO mode when the cover is closed. The terminals carry a safety extra low voltage.

Level control

The built-in level control is designed both for overflow pools with spillway and for skimmer pools. The version to be used must be specified when configuring the control unit before use: in the configuration menu select either the option **Level control - type: collect. vessel** or **Level control - type: skimmer pool**.

Overflow pools with spillway

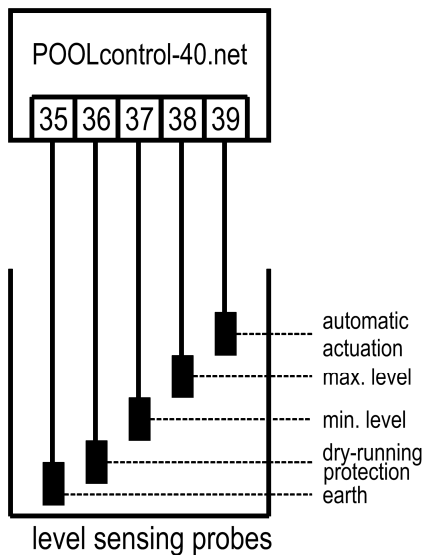

ISI electrode probes must be used as the level sensors.

Thanks to the strain relief provided for the cable, these probes can be suspended by this dedicated cable in the overflow balancing tank. It does not matter if the individual probes touch each other. The probes are fixed above the tank using the **ISI** probe holder.

The dedicated cables must be taken to a junction box installed by the customer. A cable must be laid from this junction box to the control unit (e.g. cable NYM-0 5x1.5 mm²). The cable must not exceed 30m in length. The cable must not be laid alongside mains power cables.

The probes operate with safety extra low voltage (SELV).

Take special care when fitting the probes to ensure they are connected in the correct order, because the installation will not work if the probes are mixed up.

Use with outdoor pools

Depending on the design of the pool installation, rain water in an outdoor pool can raise the water level, triggering the "automatic actuation" function. If you don't want this to happen, you can disconnect the "automatic actuation ON" probe (terminal 39). All the other probes are needed for the control function to work, so must not be omitted or bypassed.

Functions of the different level sensing probes

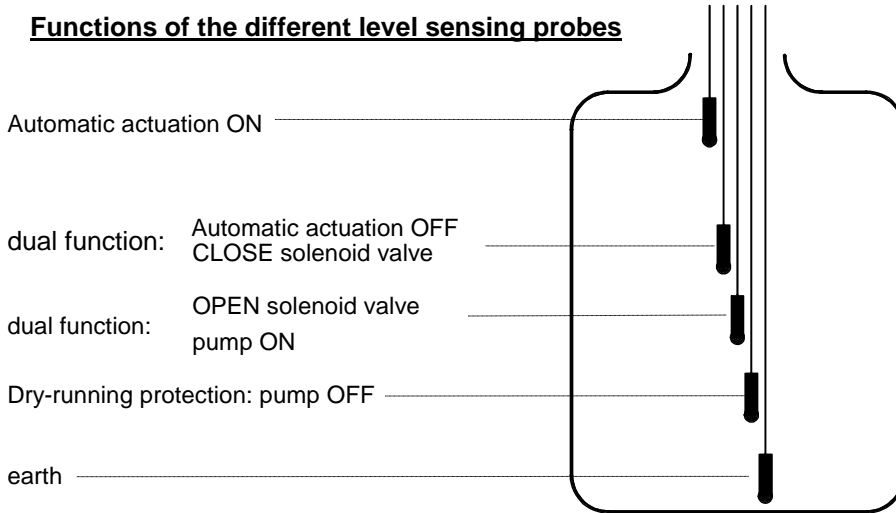

In normal mode, the water level fluctuates between the "CLOSE solenoid valve" and "OPEN solenoid valve" probes.

The height differences depend on the individual circumstances, but must be no less than 5 cm to ensure sufficient switching intervals.

How level control works for balancing tanks

Level control for balancing tanks performs the following functions:

- a. Controlling the water level.

When water is lost from the swimming pool, e.g. through evaporation or backwashing, causing the water level to drop to below the "OPEN solenoid valve" probe (terminal 37), the solenoid valve (terminal U9) opens and the inflowing fresh water causes the water level to rise. As soon as the rising water level reaches the position of the "CLOSE solenoid valve" probe (terminal 38) and touches this probe, the solenoid valve closes the supply of fresh water.

- b. Protecting the filter pump against dry-running.

When water is lost from the swimming pool, e.g. from backwashing, causing the water level to drop to below the "Dry-running protection / pump OFF" probe (terminal 36), the level control system switches off the filter pump to prevent it being damaged by running without water. As soon as the water level has returned to the height of the "Dry-running protection / pump ON" probe (terminal 37) and touches this probe, the level control system automatically switches the filter pump back on.

- c. Automatic actuation.

If water displacement in the swimming pool has increased the water level in the balancing tank so that it touches the "automatic actuation ON" probe (terminal 39), the level control system automatically switches on the filter pump. The water is then pumped back into the pool, avoiding unnecessary loss of precious water. The "automatic actuation ON" probe must be placed a few cm lower than the overspill.

Pools with skimmer

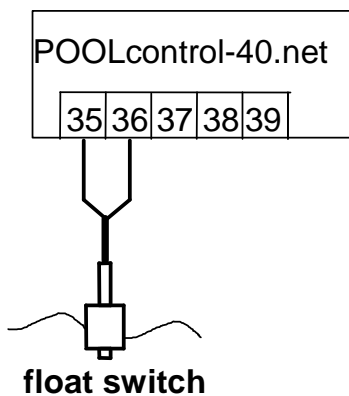

An **ISI** mini float switch must be used as the sensor for skimmer pools. The float switch lead can be extended with a cable (2x0.75mm²) of up to 30m in length. Please note that the connection must be absolutely watertight. The float-switch connecting cable must not be laid alongside other current-carrying cables.

The mini float switch operates with safety extra low voltage (SELV).

In this operating mode a time delay is automatically enabled in conjunction with the mini float switch. This adjustable time delay prevents over-frequent switching as a result of waves moving the pool water. The delay length can be adjusted in the configuration menu.

Fit the mini float switch on the sliding bracket. Then fasten the fixing rail vertically on the skimmer wall at the approximate height required for the water level. You can then set the water level by moving the sliding bracket up and down the rail. Tighten the screw to fasten the sliding bracket in place. All the parts fit easily inside each other so no great force is needed.

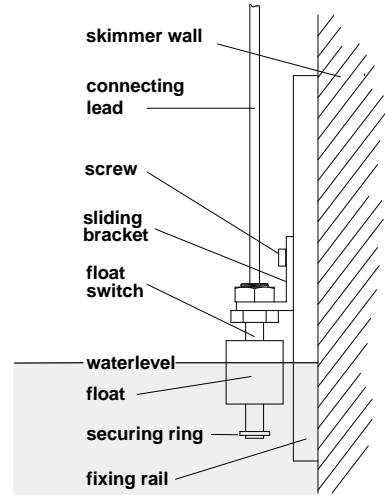

Use without level control

If you do not want to use the built-in level control, you must select the option **Level control - type: skimmer pool** in the configuration menu.

Solenoid valve for topping up the water level

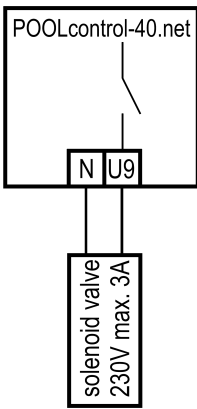

A normally closed solenoid valve must be used for the water intake. This valve must be connected to terminals U9 / N of the control unit. A suitable solenoid valve (R1/2"), part number 1090005804, is available from the **tsi** range.

Temperature sensor

Pool temperature sensor

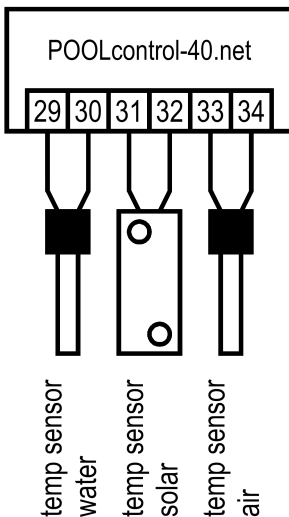

Connect the swimming-pool temperature sensor to terminals 29 and 30. The temperature sensor is supplied as standard with a cable length of 1.5m. If required, this can be extended to a maximum length of 20m using a twin-core cable (min. cross-section 0.5mm²). Avoid running the sensor lead close to mains cables to prevent potential interference.

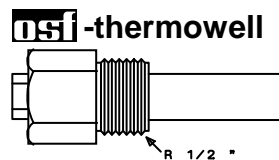

Since precise temperature control can only be achieved with good heat transfer between the temperature sensor and swimming pool water, an **tsi** R1/2" thermowell (part no. 320.020.0003) must be fitted in the piping system.

The sensors can be connected either way round (polarity not important).

Solar temperature sensor

In addition, a solar temperature sensor (part no. 3100000033) can be connected to terminals 31 and 32. The temperature sensor is supplied as standard with a cable length of 20m. If required, this can be extended to a maximum length of 50m using a twin-core cable (min. cross-section 0.5mm²). **Avoid running the sensor lead close to mains cables to prevent potential interference.** The solar temperature sensor should be fitted at the solar collector output in good thermal contact with the returning water flow. The temperature at the installation position for the temperature sensor must not exceed 80°C.

Air temperature sensor

In addition, an air temperature sensor can be connected to terminals 33 and 34. This sensor is used for controlling the automatic frost protection function.

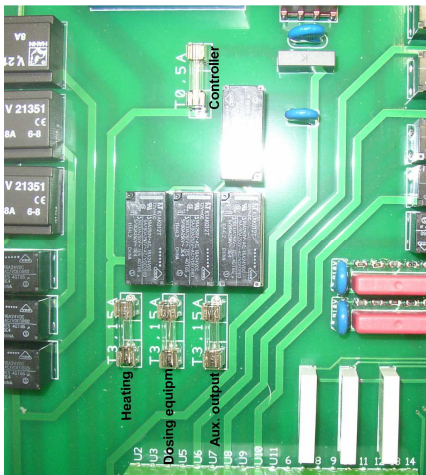

Fuses

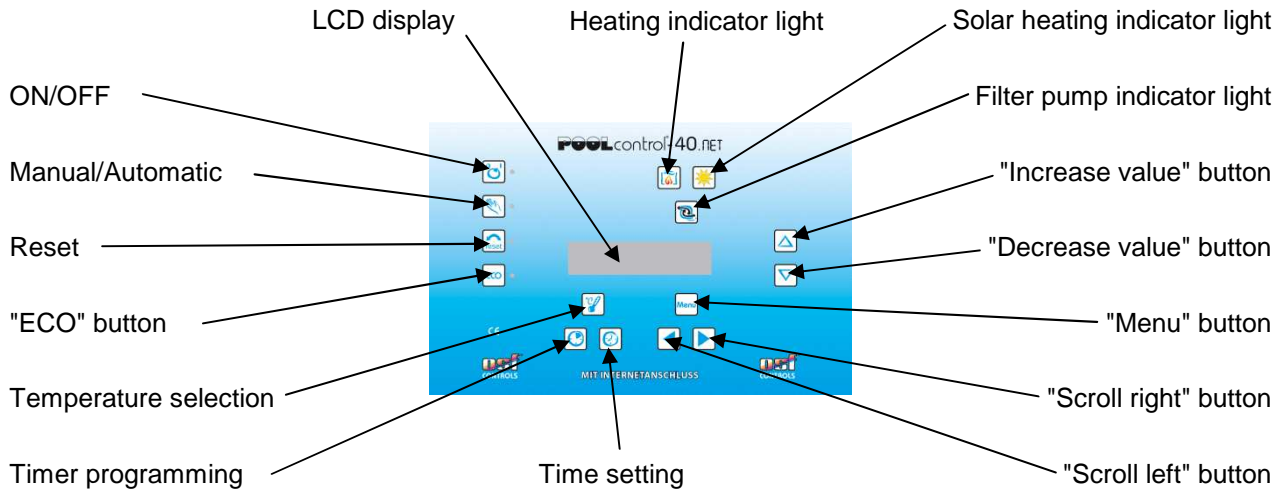

The electronic controller is protected by a 0.5A microfuse located on the printed circuit board inside the control unit. A separate 3.15A microfuse is provided for each of the following outputs: heating, dosing equipment and auxiliary output. The customer must fit mains fuses of maximum rating 16A to provide short-circuit protection for the filter pump.

Controls on the front panel



LCD	23,4°C Standby	14:46	Normal operating display showing actual time and water temperature. The filter pump is off (pause in filtration).
LCD	23,4°C Filtration	14:46	Normal operating display showing actual time and water temperature. The system is in normal filtration mode.
LCD	23,4°C Filtration ECO	14:46	Normal operating display showing actual time and water temperature. The system is running in ECO mode.
LCD	23,4°C Subsequent run	14:46	The filter pump is still running temporarily after switching off the heating.
LCD	23,4°C Forced run	14:46	The filter pump has been switched on by the built-in level control system.
LCD	23,4°C Lack of water	14:46	The filter pump has been switched off by the built-in level control system.
LCD	23,4°C Backwashing 75 s	14:46	The filter is being backwashed using the slide valve on terminal U10. The display shows the time remaining for backwashing.
LCD	23,4°C Rinseins 18 s	14:46	The filter is being rinsed using the slide valve on terminal U11. The display shows the time remaining for rinsing.
LCD	23,4°C Backwash EUROTR.	14:46	The filter is being backwashed by a Eurotronik controller connected to terminals 2-5.
LCD	23,4°C Level sensor def	14:46	The level sensors are not connected properly or are connected in the wrong order.
LCD	23,4°C Pump locked	14:46	The filter pump has been switched off by a connected EUROTRONIK-10 controller or the winding protection switch.
LCD	23,4°C Pump overloaded	14:46	The filter pump has been switched off by the electronic motor protection device. To switch the pump back on, press the  button once the pump has cooled down.
LCD	23,4°C No water flow	14:46	The filter pump has been switched off by the flow sensor connected to terminals 21 and 22. To switch the pump back on, press the  button once the fault has been rectified.
LCD	23,4°C Netphase missing	14:46	The filter pump has been switched off because current is not flowing in all three phases of the 3-phase supply. To switch the pump back on, press the  button once the fault has been rectified.
LCD	Sensor def. 14:46 Filtration		Temperature control not working because the temperature sensor is disconnected or faulty.



Control unit

This button can be used to switch the entire control unit on and off. **Caution!** This does not disconnect the control unit from the power supply

ON/OFF**Manual operation**

This button is illuminated when the control unit is on.

This button can be used to switch on the filter pump manually, independently of the timer. This button is illuminated during manual operation.

**Reset
fault indicator**

This button shows a red light if the control unit detects a fault (e.g. motor protection tripped). The system can only resume normal operation once the fault indicator has been cleared by pressing this button.

**ECO
ON/OFF**

This button can be used to switch ECO mode on and off (energy saving mode).

**Pump indicator
light**

This indicator light indicates when the filter pump is running.

**Heating indicator
light**

This indicator light is illuminated when the heating (heat exchanger) is on.

**Solar heating
indicator light**

This indicator light is illuminated when the solar heating is running.

**Adjustment
buttons**

These buttons can be used to program water temperature, time, timer settings and backwash times. These buttons can also be used to alter values in the configuration menu.

**Temperature
selection**

Use this button to select the water temperature for the swimming pool:

1. Press the button ⇒ the display shows .
2. You can now use the and buttons to set the temperature you require in the range 0.1°C to 40°C.
3. To save the required temperature, press the button again. If more than 10 seconds pass without any button being pressed when setting the temperature, the last temperature selected is saved automatically and the normal operation display reappears.

If a solar sensor is connected to the control unit, you can use this button to display the current temperature at the solar sensor:

1. Press the button twice ⇒ the display shows the temperature at the solar sensor, e.g. .
2. To close this display, press the button again. If more than a minute passes without any button being pressed, the normal operation display reappears automatically.

If an air temperature sensor is connected to the control unit, you can use this button to display the current air temperature:

3. Press the button three times ⇒ the display shows the air temperature, e.g. .
4. To close this display, press the button again. If more than a minute passes without any button being pressed, the normal operation display reappears automatically.

**Setting the time**

Use this button to set the actual time:

1. Press the button ⇒ the display shows: . The day of the week flashes.
2. Use the and buttons to select whether you want to set the day, hour or minutes. The relevant text flashes.
3. Use the and buttons to make the setting for the currently flashing text (day, hour or minutes).
4. To save the time, press the button again. If more than 5 seconds

pass without any button being pressed when making the setting, programming is aborted without any settings being saved. The normal operation display reappears.



Timer programming

Use this button to program the built-in timer. Note that the switch-on time and the associated switch-off time must always be entered as a pair:

1. Press the button ⇒ the display shows `switch.time 01`
`Su10:00-Su20:00` . The bottom line shows the currently set switch-on and switch-off times (Dy means daily). The number in the top right indicates the number of the pre-programmed timer setting (01 means 1st timer setting).
2. Press the button. The day of the week flashes.
3. Use the and buttons to select whether you want to set the day, hour or minutes. The relevant text flashes.
4. Use the and buttons to make the setting for the currently flashing text (day, hour or minutes). ON in the top line means switch-on time.
5. Press the button to save the timer setting.
6. The display automatically shows the menu for setting the switch-off time. The day of the week flashes.
7. Use the and buttons to select whether you want to set the day, hour or minutes. The relevant text flashes.
8. Use the and buttons to make the setting for the currently flashing text (day, hour or minutes). OFF in the top line means switch-off time.
9. Press the button to save the timer setting.
10. Repeat steps 1-9 if you wish to program further timer settings.

Changing the timer settings

Pre-programmed timer settings can be changed as follows:

1. Press the button ⇒ the display shows `switch.time 01`
`Su10:00-Su20:00` . The bottom line shows the currently set switch-on and switch-off times (Dy means daily).
2. If more than one timer setting is programmed, you can use the and buttons to select the timer setting you require. (Check the number in the top right).
3. Press the button. The day of the week flashes.
4. Use the and buttons to select whether you want to alter the day, hour or minutes. The relevant text flashes.
5. Use the and buttons to change the setting for the currently flashing text (day, hour or minutes).
6. Press the button to save the changes.











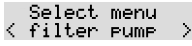



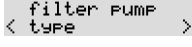



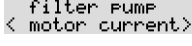



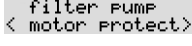

Clearing the timer settings



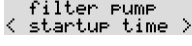







































Pre-programmed timer settings can be cleared as follows:















































1. Press the button ⇒ the display shows `switch.time 01`
`Su10:00-Su20:00` . The bottom line shows the currently set switch-on and switch-off times (Dy means daily).
2. If more than one timer setting is programmed, you can use the and buttons to select the timer setting you require. (Check the number in the top right)
3. Press the button. The day of the week flashes.
4. Use the and buttons to change the setting for the currently flashing text. To clear the setting, select "not progr." (short for "not programmed").

5. Press the  button to clear the timer setting.





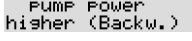
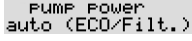









































Configuration menu







































Filter pump		<p>Press the  button.</p> <p>Use the  and  buttons to scroll through the menu until the display shows "filter pump".</p> <p>Press the  button again to select filter pump mode.</p>
Type		<p>Press the  button.</p> <p>The display shows the currently selected type of filter pump (3-phase pump, single-phase AC pump or variable speed pump). You can use the  and  buttons to change the selection. Press the  button to save the setting.</p> <p style="text-align: right;">Factory setting: 3-phase pump</p>
Motor current		<p>Use the  and  buttons to scroll through the filter pump mode until the display shown here appears.</p> <p>Press the  button. The display shows the instantaneous current consumption of the filter pump.</p>
Motor protection		<p>Use the  and  buttons to scroll through the filter pump mode until the display shown here appears.</p> <p>Press the  button. The display shows the motor protection trip current. You can use the  and  buttons to change the setting. Press the  button to save the setting.</p> <p style="text-align: right;">Adjustment range 0.5 to 8A, factory setting 4A</p>
Startup time		<p>Use the  and  buttons to scroll through the filter pump mode until the display shown here appears.</p> <p>Press the  button to set the startup time using the  and  buttons. Press the  button to save the setting.</p> <p>The startup time is the time that elapses after the filter pump starts running before the flow sensor reading is retrieved.</p> <p style="text-align: right;">Adjustment range 5 to 60s, factory setting 10s</p>









































ECO mode	<pre> Select menu < ECO-mode > </pre>	<p>Press the  button.</p> <p>Use the  and  buttons to scroll through the menu until the display shows "ECO mode".</p> <p>Press the  button again to select ECO mode.</p>
Timer	<pre> ECO-mode < timer > </pre>	<p>Press the  button to program the timer settings (see procedure described under Timer programming)</p>
Temperature reduction	<pre> ECO-mode < Temp. reduct. > </pre>	<p>Use the  and  buttons to scroll through the ECO mode until the display shown here appears.</p> <p>Press the  button to set the temperature reduction using the  and  buttons. Then press the  button to save the setting.</p> <p style="text-align: center;">Adjustment range 0 to 15°, factory setting 0°</p>
Heating	<pre> Select menu < heating > </pre>	<p>Press the  button.</p> <p>Use the  and  buttons to scroll through the menu until the display shows "heating".</p> <p>Press the  button to select the heating settings.</p>
Operating mode	<pre> heating < operation mode > </pre>	<p>Press the  button.</p> <p>The display shows the current heating operating mode (automatic mode or off). You can use the  and  buttons to change the selection. Press the  button to save the setting.</p>
Priority	<pre> heating < Priority > </pre>	<p>Use the  and  buttons to scroll through the heating settings until the display shown here appears.</p> <p>Press the  button to enable or disable the priority using the  and  buttons. Press the  button to save the setting. With priority off (disabled), the heating is only actuated during filtration operating times.</p> <p style="text-align: center;">Factory setting: priority off</p>
Minimum switching interval	<pre> heating < minim.sw-time > </pre>	<p>Use the  and  buttons to scroll through the heating settings until the display shown here appears.</p> <p>Press the  button to set the minimum switching interval (hysteresis) using the  and  buttons. Press the  button to save the setting. The minimum switching interval is set in seconds.</p> <p style="text-align: center;">Adjustment range 10 to 1800s, factory setting 120s</p>
Over-run time	<pre> heating < subseq. run > </pre>	<p>Use the  and  buttons to scroll through the heating settings until the display shown here appears.</p> <p>Press the  button to set the over-run time (subseq. run) using the  and  buttons. Press the  button to save the setting. When an over-run time is active, the timer switches the heating off at the end of the filtration operating time, but the filter pump keeps running for the period set by the over-run time.</p> <p style="text-align: center;">Adjustment range 0 to 1800s, factory setting 0s</p>
Temperature limit	<pre> heating < temp. limit > </pre>	<p>Use the  and  buttons to scroll through the heating settings until the display shown here appears.</p> <p>Press the  button to set the temperature limit using the  and  buttons. Press the  button to save the setting. The temperature limit is the maximum water temperature that can be selected.</p> <p style="text-align: center;">Adjustment range 30 to 50°C, factory setting 40°C</p>

<p>Solar heating</p>	<p>Select menu < solar heating ></p>	<p>Press the  button.</p> <p>Use the  and  buttons to scroll through the menu until the display shows "solar heating".</p> <p>Press the  button to select the solar heating settings.</p>
<p>Operating mode</p>	<p>solar heating < operation mode ></p>	<p>Press the  button.</p> <p>The display shows the current operating mode for the solar heating (automatic mode or off). You can use the  and  buttons to change the selection. Press the  button to save the setting.</p>
<p>Priority</p>	<p>solar heating < Priority sol. ></p>	<p>Use the  and  buttons to scroll through the solar heating settings until the display shown here appears.</p> <p>Press the  button to enable or disable the priority using the  and  buttons. Press the  button to save the setting. With priority on (enabled), the solar heating (and simultaneously the filter pump) is also actuated outside filtration operating times.</p> <p style="text-align: center;">Factory setting: priority on</p>
<p>Minimum switching interval</p>	<p>solar heating < minim. sw-time ></p>	<p>Use the  and  buttons to scroll through the solar heating settings until the display shown here appears.</p> <p>Press the  button to set the minimum switching interval (hysteresis) using the  and  buttons. Press the  button to save the setting. The minimum switching interval is set in seconds.</p> <p style="text-align: center;">Adjustment range 10 to 1800s, factory setting 120s</p>
<p>Switch-on difference</p>	<p>solar heating < Solar ON dT ></p>	<p>Use the  and  buttons to scroll through the solar heating settings until the display shown here appears.</p> <p>Press the  button to set the switch-on difference (difference between pool temperature and solar temperature) using the  and  buttons. Press the  button to save the setting.</p> <p style="text-align: center;">Adjustment range 0.5 to 20°C, factory setting 5°C</p>
<p>Switch-off difference</p>	<p>solar heating < Solar OFF dT ></p>	<p>Use the  and  buttons to scroll through the solar heating settings until the display shown here appears.</p> <p>Press the  button to set the switch-off difference (difference between pool temperature and solar temperature) using the  and  buttons. Press the  button to save the setting.</p> <p style="text-align: center;">Adjustment range 0 to 15°C, factory setting 0°C</p>
<p>Temperature boost</p>	<p>solar heating < Temp. increase ></p>	<p>Use the  and  buttons to scroll through the solar heating settings until the display shown here appears.</p> <p>Press the  button to set the solar heating temperature boost using the  and  buttons. Press the  button to save the setting. The pool temperature is only boosted by the set value during solar operation.</p> <p style="text-align: center;">Adjustment range 0 to 15°C, factory setting 5°C</p>
<p>Pump speed</p>	<p>solar heating < PUMP Power ></p>	<p>Use the  and  buttons to scroll through the solar heating settings until the display shown here appears.</p> <p>Press the  button to set the filter pump speed using the  and  buttons.</p> <p>The following settings are possible (only for variable-speed filter pump):</p> <p> In solar operating mode, the filter pump runs at "filtration" speed.</p> <p> In solar operating mode, the filter pump runs at the higher "backwash" speed.</p> <p> In solar operating mode, the filter pump runs at the speed for the current operating mode, either "ECO mode = low speed" or "filtration mode = filter speed".</p> <p>Press the  button to save the setting.</p>

Factory setting: filter speed

<p>Frost protection</p> <p>Select menu < frost protect ></p>	<p>Press the  button.</p> <p>Use the  and  buttons to scroll through the menu until the display shows "Frost protection".</p> <p>Press the  button to select the frost protection settings.</p>
<p>Operating mode</p> <p>frost protect < operation mode ></p>	<p>Press the  button.</p> <p>The display shows the current operating mode for the frost protection function (automatic mode or off). You can use the  and  buttons to change the selection. Press the  button to save the setting.</p>
<p>Air temperature</p> <p>frost protect < Air temperat. ></p>	<p>Use the  and  buttons to scroll through the frost protection settings until the display shown here appears.</p> <p>Press the  button to use the  and  buttons to set the air temperature at which frost protection will start operating. Press the  button to save the setting.</p> <p>Adjustment range -5°C to +5°C, factory setting 0°C</p>
<p>Water temperature</p> <p>frost protect < water temp. ></p>	<p>Use the  and  buttons to scroll through the frost protection settings until the display shown here appears.</p> <p>Press the  button to use the  and  buttons to set the target water temperature for frost protection. Press the  button to save the setting.</p> <p>Adjustment range 0°C to 20°C, factory setting 5°C</p>
<p>Backwashing</p> <p>Select menu < backwashing ></p>	<p>Press the  button.</p> <p>Use the  and  buttons to scroll through the menu until the display shows "backwashing".</p> <p>Press the  button to select the settings for backwashing using slide valves.</p>
<p>Operating mode</p> <p>backwashing < operation mode ></p> <p>operation mode start manually</p> <p>operation mode automatic mode</p>	<p>Press the  button to set the backwash start condition using the  and  buttons.</p> <p>The following options can be set:</p> <p>Press the  button to start backwashing immediately.</p> <p>Press the  button to start backwashing under timer control. Press the  button to save the setting.</p>
<p>Timer</p> <p>backwashing < Timer ></p>	<p>Use the  and  buttons to scroll through the backwashing settings until the display shown here appears.</p> <p>Press the  button to program the timer settings (see Procedure described under Timer programming).</p>
<p>Stop backwashing</p>	<p>Press the  button to switch off the control unit. This terminates the backwash cycle.</p>
<p>Backwash period</p> <p>backwashing < Durat. backw. ></p>	<p>Use the  and  buttons to scroll through the backwashing settings until the display shown here appears.</p> <p>Press the  button to use the  and  buttons to set how long the backwash cycle should last. Press the  button to save the setting.</p>
<p>Rinse period</p> <p>backwashing < Durat. rinse. ></p>	<p>Use the  and  buttons to scroll through the backwashing settings until the display shown here appears.</p> <p>Press the  button to use the  and  buttons to set how long the rinse cycle should last. Press the  button to save the setting.</p> <p>Adjustment range 0 to 120s, factory setting 30s</p>

Valve delay	backwashing < valve delay >	<p>Use the  and  buttons to scroll through the backwashing settings until the display shown here appears.</p> <p>Press the  button to use the  and  buttons to set how long the filter pump should stop running whenever the slide valves are operated. Press the  button to save the setting.</p>
		Adjustment range 0 to 120s, factory setting 0s
Fortnightly	backwashing < fortnightly >	<p>Use the  and  buttons to scroll through the backwashing settings until the display shown here appears.</p> <p>Press the  button to use the  and  buttons to set whether filter backwashing should be performed only once a fortnight. Press the  button to save the setting.</p>
		Factory setting: disabled (weekly backwashing)
Use main drain	backwashing < Floor Drain >	<p>Use the  and  buttons to scroll through the backwashing settings until the display shown here appears.</p> <p>Press the  button to use the  and  buttons to set whether the main drain (floor drain) should be opened during backwashing. Press the  button to save the setting.</p>
		Factory setting: backwashing without main drain
Level control	Select menu < level control >	<p>Press the  button.</p> <p>Use the  and  buttons to scroll through the menu until the display shows "level control".</p> <p>Press the  button to select the level control settings.</p>
Type	level control < type >	<p>Press the  button.</p> <p>The display shows the currently selected type of level control (skimmer pool or balancing tank ("collecting vessel")). You can use the  and  buttons to change the selection. Press the  button to save the setting.</p>
		Factory setting: skimmer pool
Time limit	level control < time limit >	<p>Use the  and  buttons to scroll through the level control settings until the display shown here appears.</p> <p>Press the  button to set the time limit using the  and  buttons. Press the  button to save the setting. After the set time has expired, the solenoid valve is switched off regardless of the water level.</p>
		Adjustment range 0 to 240 minutes, factory setting 60 minutes
		0 means no time limit.
Minimum switching interval	level control < minim.sw-time >	<p>Use the  and  buttons to scroll through the level control settings until the display shown here appears.</p> <p>Press the  button to set the minimum switching interval using the  and  buttons. Press the  button to save the setting. The minimum switching interval is the time difference between switching operations when using a mini float switch as sensor.</p>
		Adjustment range 10 to 180s, factory setting 10s

<p>Auxiliary output</p> <p>Select menu < auxil. output ></p>	<p>Press the  button.</p> <p>Use the  and  buttons to scroll through the menu until the display shows "auxil. output".</p> <p>Press the  button to select the settings for the auxiliary output (U4).</p>
<p>Operating mode</p> <p>auxil. output < operation mode ></p> <p>operation mode switched ON</p> <p>operation mode switched OFF</p> <p>operation mode automatic mode</p>	<p>Press the  button to select the operating mode using the  and  buttons.</p> <p>The following options can be set:</p> <p>The auxiliary output is permanently on.</p> <p>The auxiliary output is permanently off.</p> <p>The auxiliary output is controlled by its timer.</p> <p>Press the  button to save the setting.</p>
<p>Timer</p> <p>auxil. output < Timer ></p>	<p>Use the  and  buttons to scroll through the auxiliary output settings until the display shown here appears.</p> <p>Press the  button to program the timer. (See Procedure described under Timer programming).</p>
<p>Cycle time</p> <p>auxil. output < Cycle time ></p>	<p>Use the  and  buttons to scroll through the auxiliary output settings until the display shown here appears.</p> <p>Press the  button to set the cycle time using the  and  buttons.</p> <p>Press the  button to save the setting. The auxiliary output is switched on and off on the basis of this setting. A setting of 0 minutes means that there is no cycling of the auxiliary output on and off.</p> <p style="text-align: center;">Adjustment range 0 to 240 minutes, factory setting 0</p>
<p>ON period</p> <p>auxil. output < Pulse duration ></p>	<p>Use the  and  buttons to scroll through the auxiliary output settings until the display shown here appears.</p> <p>Press the  button to set the ON period (pulse duration) using the  and  buttons. This does not affect the cycle time. Press the  button to save the setting.</p> <p style="text-align: center;">Adjustment range 5 to 240s, factory setting 10s</p>
<p>Interlock</p> <p>auxil. output < Interlocking ></p>	<p>Use the  and  buttons to scroll through the auxiliary output settings until the display shown here appears.</p> <p>Press the  button to use the  and  buttons to select whether the auxiliary output is meant to be interlocked to the filter pump.</p> <p>Press the  button to save the setting. When the interlock is enabled, the auxiliary output is only switched on during filtration.</p> <p style="text-align: center;">Factory setting: no interlock</p>
<p>Network (LAN)</p> <p>Select menu < network (LAN) ></p>	<p>Press the  button.</p> <p>Use the  and  buttons to scroll through the menu until the display shows "network (LAN)".</p> <p>Press the  button to select to display the network parameters.</p>
<p>IP address</p> <p>network (LAN) < IP-Address ></p>	<p>Press the  button to display the current IP address for the unit.</p>
<p>Device ID</p> <p>network (LAN) < Device-ID ></p>	<p>Use the  and  buttons to scroll through the network details until the display shown here appears.</p> <p>Press the  button to display the device ID used to denote the unit in the USI communications server.</p>
<p>User PIN</p> <p>network (LAN) < User PIN ></p>	<p>Use the  and  buttons to scroll through the network details until the display shown here appears.</p> <p>Press the  button to display the current PIN number for the end customer.</p>

Factory setting: 1234		
Service PIN	<pre>network (LAN) < Service PIN ></pre>	<p>Use the ◀ and ▶ buttons to scroll through the network details until the display shown here appears.</p> <p>Press the <input type="button" value="Menu"/> button to display the current PIN number for the service engineer.</p>
Factory setting: 5678		
Sensor calibration		<p>Press the <input type="button" value="Menu"/> button.</p>
	<pre>Select menu < Calibr.sensors ></pre>	<p>Use the ◀ and ▶ buttons to scroll through the menu until the display shows "Calibr.sensors".</p> <p>Press the <input type="button" value="Menu"/> button to select the sensor calibration function.</p>
Water temperature	<pre>Calibr.sensors < water temp. ></pre>	<p>Press the <input type="button" value="Menu"/> button to adjust the water temperature indicator using the ▲ and ▼ buttons. Press the <input type="button" value="Menu"/> button to save the setting.</p>
Solar temperature	<pre>Calibr.sensors < solar temp. ></pre>	<p>Use the ◀ and ▶ buttons to scroll through the sensor calibration menu until the display shown here appears.</p> <p>Press the <input type="button" value="Menu"/> button to adjust the solar temperature indicator using the ▲ and ▼ buttons. Press the <input type="button" value="Menu"/> button to save the setting.</p>
Air temperature	<pre>Calibr.sensors < Air temperat. ></pre>	<p>Use the ◀ and ▶ buttons to scroll through the sensor calibration menu until the display shown here appears.</p> <p>Press the <input type="button" value="Menu"/> button to adjust the air temperature indicator using the ▲ and ▼ buttons. Press the <input type="button" value="Menu"/> button to save the setting.</p>
Language		<p>Press the <input type="button" value="Menu"/> button.</p>
	<pre>Select menu < language ></pre>	<p>Use the ◀ and ▶ buttons to scroll through the menu until the display shows "language".</p> <p>Press the <input type="button" value="Menu"/> button to select the language for the front panel display.</p>
Language selection	<pre>select lang. english</pre>	<p>Press the <input type="button" value="Menu"/> button to select the language using the ▲ and ▼ buttons. Press the <input type="button" value="Menu"/> button to save the setting.</p>

Internet connection

Access to the Internet is provided via the **osf** communications server. Use a standard patch cable (network cable) to connect the POOLcontrol-40.net to the network socket, the Powerline adapter, the Wireless LAN Access Point or other suitable installation.

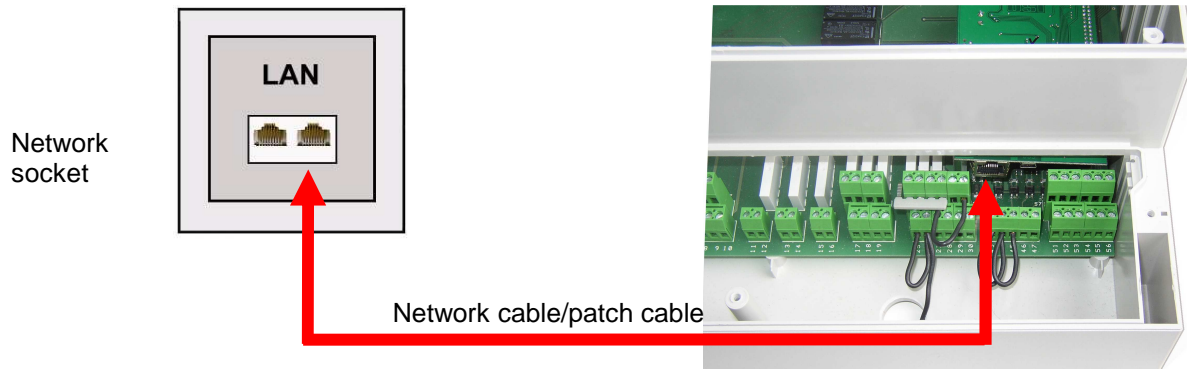

Once the POOLcontrol-40.net has been connected to an active network socket, you can then switch on the power supply. The **osf** web server in the POOLcontrol-40.net automatically locates the **osf** communications server and registers itself with the communications server database.

Using the osf communications server

You can access the osf communications server at the address <http://devices.osf.de>.

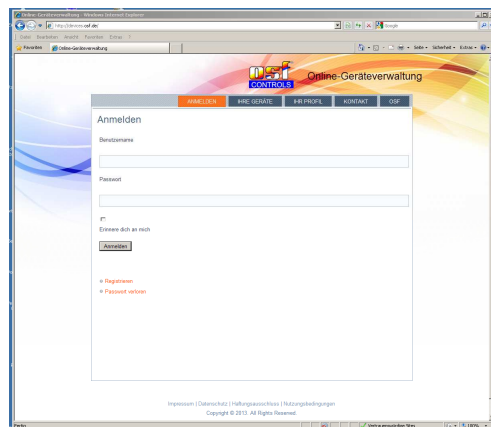

You must first register as a new user:

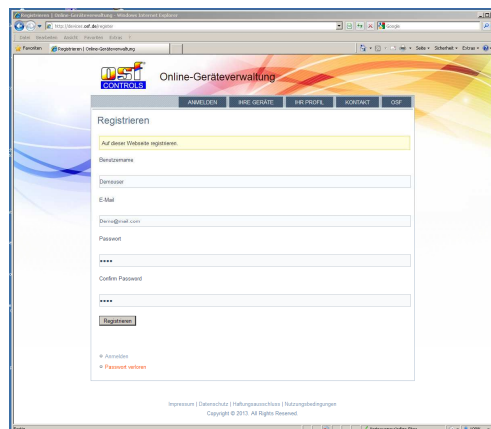

Once you have registered, you can log in and then register your new device in your user profile:

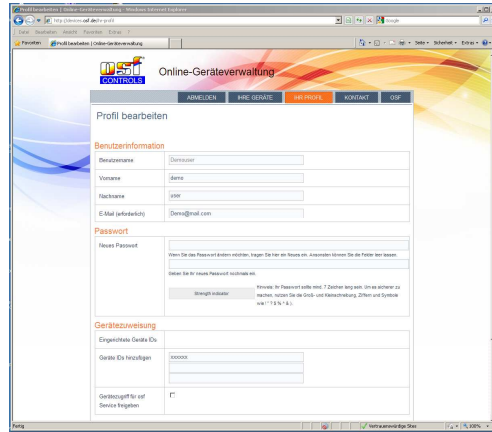

You can find the DEVICE ID of your unit from the unit's configuration menu (see above).

Your unit is then displayed in your device overview and can be operated via the communications server:

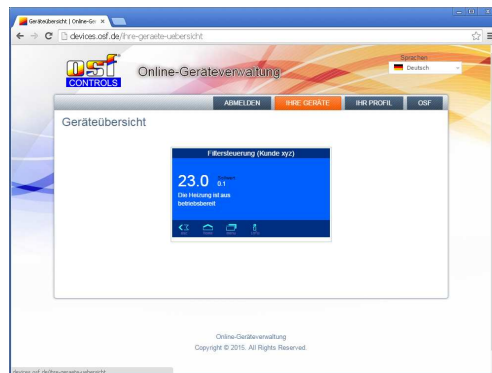

In order to use the communications server, the option "Internet connection via communication server" must be enabled (factory setting):

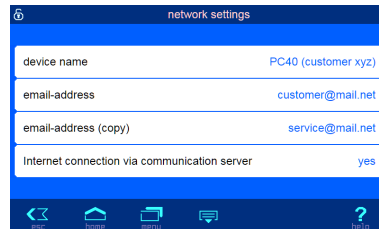

Operating the unit via the web server





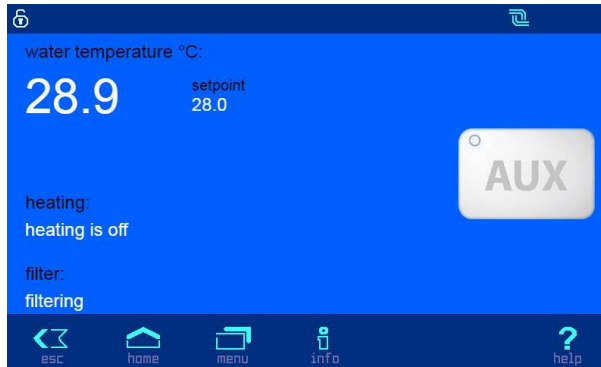

Once the unit has established a connection to the network, it can be operated via the built-in web server. You can use any web browser to communicate with the web server. For connections from the Internet, the web server can be accessed via the **US1** communications server. Alternatively, for access via a local area network, you can also enter the IP address of the device directly in the address line of your browser (IP address can be found from the Configuration menu). If you are operating the unit from a machine that can handle NETBIOS name resolution (e.g. a Windows PC), you can also use the NETBIOS name "PC40" instead of the IP address (<http://PC40>).

Home page





The home page is the first page displayed after opening the unit in your web browser:



Icons in the status bar

-  The web server is locked against access from the LAN. The page simply displays the current status. To be able to operate the unit, you must first log in after clicking this icon.
-  The web server has been opened for full access using the Service PIN.
-  The solenoid valve for water top-up is open.
-  Filter backwashing is in progress.
-  The filter pump is running.
-  Heating is running.
-  Solar heating is running.

Icons in the control bar

-  Navigate to system information page
-  Navigate to home page
-  Navigate to main menu
-  Navigate to information page
-  Open online Help

User login

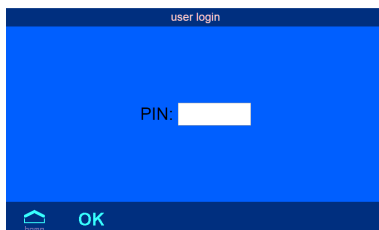

This is the page where the operator must log into the unit by entering the user PIN (factory setting 1234) or Service PIN (factory setting 5678) in order to be allowed to operate the unit.

System information page



This page displays system information about the unit e.g. serial number and software version. The logged-in user can also find here the current IP address for access from the local area network and the Device ID for access via the  communications server.

Information page

This page shows graphically the current operating status of the pool control unit.

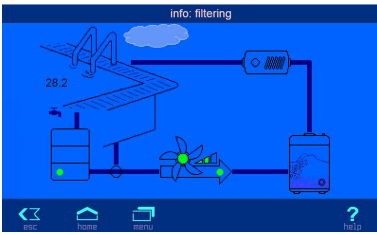

Main menu

This is the page where you can make various settings for the pool control unit. The language for the web server can also be set here.

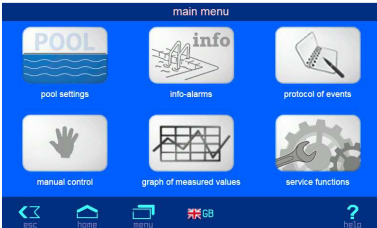

You (the user) can make the most common filter installation settings from this submenu.



The current operating status can be opened from this submenu.



The operating protocol for the filter control unit can be opened from this submenu.



The installation can be manually controlled from this submenu.



In this submenu, you can open the temperature curves stored as CSV files for graphical display and for processing using spreadsheet software.



In this submenu, the service engineer can make advanced settings for the filter installation (login using Service PIN required).

Pool settings

On this page, you (the user) can select which settings you wish to change for the pool control unit.

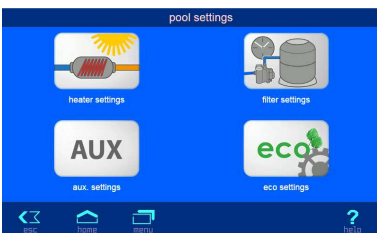

Settings for the various pool-heating operating modes.



Settings for filtration and automatic backwashing.



Settings for the auxiliary output.



Settings for ECO mode.

Heating settings

Temperature setpoint

On this page, you can set the temperature you require for the swimming pool.

You can also select the operating modes for the different heating systems. Solar heating can only be enabled if a solar sensor is connected.

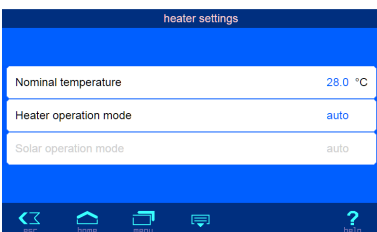

Frost protection function

This is the page where you can make settings for the frost protection function.

Frost protection can only be used if an air temperature sensor is connected.

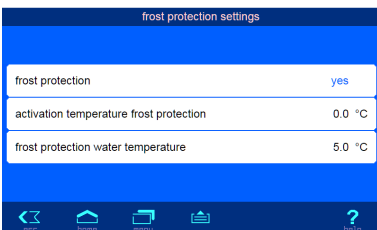

Settings for the filter installation

This is the page where you can select the timers for the filter pump and backwashing using slide valves.

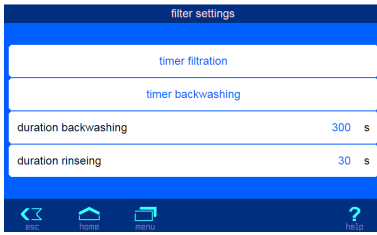

Settings for the auxiliary output

This is the page where you can make settings for the auxiliary output.

The timer can be used to define the operating times for the output. If the output is meant to be switched periodically, the cycle time and the ON period can be set here. A cycle time of 0 minutes means that the output is not switched periodically.

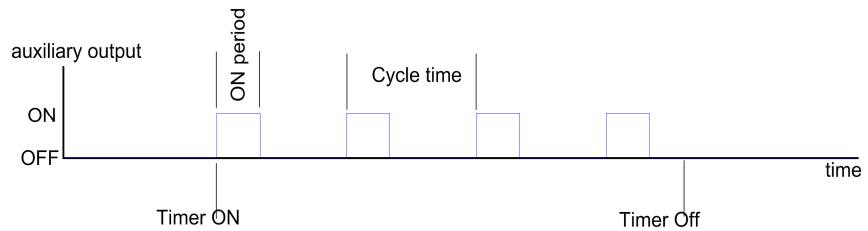
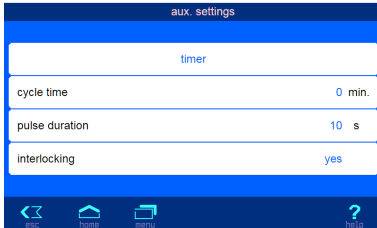

You can also specify here whether the output is meant to be interlocked to the filter pump.

Settings for ECO mode

You can select the timer for ECO mode on this page.

You can also set the reduction in water temperature for ECO mode.

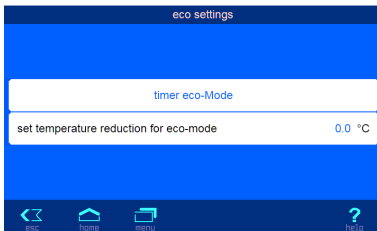

Settings for the service engineer

This is the page where the service engineer can make settings. Any changes to these settings requires prior login using the Service PIN.

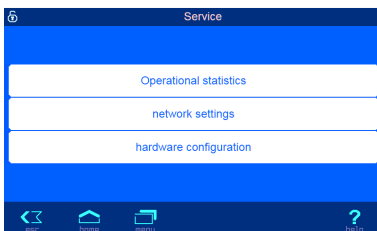

Operating statistics

A range of operating hours counters and counters for specific operating states can be read from this page.

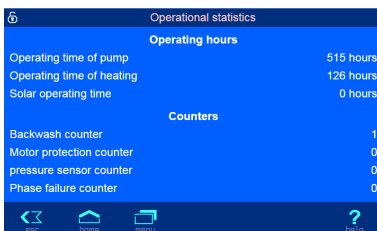

Network settings

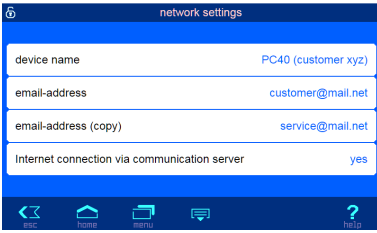

On this page you can specify the name that shall denote the unit in the **OSI** communications server.

In addition, you can set email addresses for automatic notification in the event of a fault.

You can also disable the link to the **OSI** communications server here.

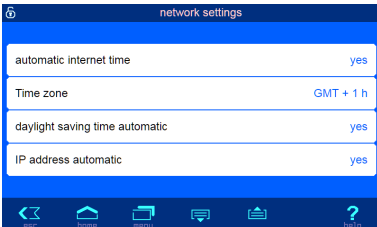

On this page, you can make settings for synchronizing the built-in clock automatically with the Internet.

You can also specify whether the unit obtains its IP settings automatically from the network (DHCP).

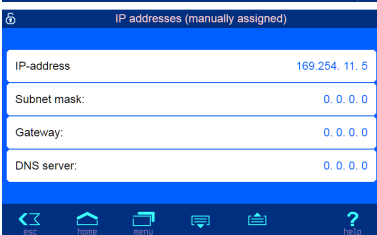

If they are not meant to be obtained automatically from the DHCP server, you can specify the IP addresses of the unit manually on this page.

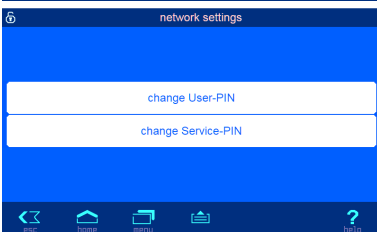

This is the page where the PIN numbers for users and service engineers can be changed. If "0000" is set as the PIN, then login using a PIN is not needed.

Hardware configuration

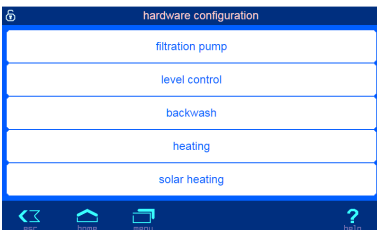

On this page, you can select which pool components you wish to configure.

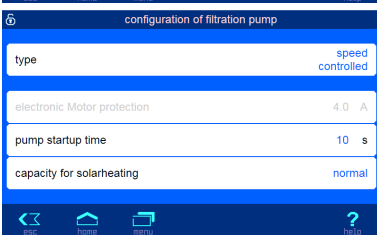

On this page, you can select the type of filter pump.

For 3-phase pumps, you must also set here the electronic motor protector to the rated current of the pump (specified on the type plate).

In addition, you can set the pump startup time, during which the flow sensor input is not polled.

For variable speed pumps, you can also select here the pump speed during solar operation.

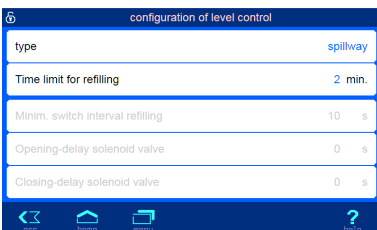

This page is where you set the type of level control.

You can also set a time limit for topping up with water.

If a skimmer pool has been selected for level control, the minimum switching interval for the solenoid valve can be set here.

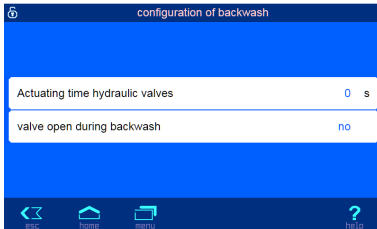

This page is where you can set how long the filter pump is meant to be inactive while the backwash slide valves are operating.

You can also specify here whether the main drain valve is meant to be opened during backwashing.

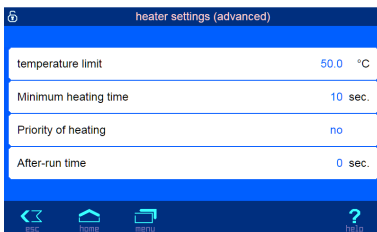

This is the page where you can make advanced settings for the heat exchanger heating system.

The temperature limit defines how high you are allowed to set the required water temperature for the swimming pool.

The minimum heating time actually defines a switching interval for limiting how often the heat exchanger switches on/off when the water temperature readings are fluctuating.

You can also set here whether the temperature control has priority over the filter timer, i.e. the temperature control can switch on the pump even outside the programmed filtration times.

You also have the option to set an after-run time, which specifies how long the filter pump continues to run after the heating is switched off in order to take residual heat away from the heat exchanger.

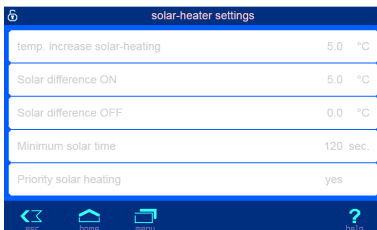

This is the page where you can make advanced settings for the solar heating system.

The temperature increase for solar heating defines how much the pool water can be heated in solar mode above the specified required temperature in order to store energy for times without incident sunlight.

The ON and OFF solar differences are the temperature differences between solar absorber and pool water at which the solar heating is switched on and off again respectively.



The minimum solar time actually defines a switching interval for limiting how often the solar heating switches on/off when the temperature readings are fluctuating.

You can also set here whether the solar temperature control has priority over the filter timer, i.e. the temperature control can switch on the pump even outside the programmed filtration times.

Interfacing with building automation systems

The POOLcontrol-40.net contains an HTTP web server, which is designed to allow the control unit to be operated using any web browser from any web-enabled terminal.

The HTML pages generated by this web server can also be accessed by a building automation system and can be interpreted for display on EIB visualization devices. For the purpose of controlling the POOLcontrol-40.net, the building automation system can generate IP messages, in the same way as they would be generated by a web browser when you click on controls on the HTML pages. In other words, the building automation system must emulate a web browser.

Instead of using directly the predefined HTML pages designed by  for displaying on web browsers, you (as user) can also design your own control file to obtain the data you require in "custom" form, and save this file on the SD card in the POOLcontrol-40.net. This means that the interface to the building automation system is then unaffected by potential design changes to the  HTML pages.

This control file must be saved as an ASCII text file with the extension ".HTM" in the "HTML" folder on the SD card. The file name must not exceed 8 characters in length. Although it has the "HTM" extension, this file need not necessarily be a valid HTML file, but can be formatted to suit the requirements of the building automation system.

This control file can contain variables in the format "\$\$nnnn", which the web server then replaces with the data that is currently valid. A list of available variables appears at the end of this document.

A control file "ISTWERTE.HTM" containing the following:

```
Water temperature: $$0100 °C
Solar temperature: $$0101 °C
Air temperature: $$0102 °C
$$0015
```

would, on opening "http://xxx.xxx.xxx.xxx/istwerte.htm", return the following text for example:

```
Water temperature: 24.3 °C
Solar temperature: 36.8 °C
Air temperature: 22.4 °C
Filtering
```

These control files can also be used selectively to read specific datapoints, e.g. "WTEMP.HTM" containing the following:

```
$$0100
```

returns

```
24.3
```

In order to make changes to data in the control unit from the building automation system, the building automation system must emulate sending an HTML form. This is done by a URL invocation in the form "http://xxx.xxx.xxx.xxx/modify?nnnn=data", where nnnn is the number of the variable to be changed, and data represents the data to be stored.

Before the building automation system can change any variables, it must first log in by sending a valid PIN number to the variable 0003:

"http://xxx.xxx.xxx.xxx/modify?0003=dddd", where dddd is the user PIN configured in the unit.

Variables can be set after successful login, e.g. set the required temperature to 28.3°C:

"http://xxx.xxx.xxx.xxx/modify?0110=28.3".

Afterwards, the building automation system should log out by writing to the variable 0003 again with any invalid value:

"http://xxx.xxx.xxx.xxx/modify?0003=0000"

A similar invocation sequence can be used, for instance, to toggle manual mode:

"http://xxx.xxx.xxx.xxx/modify?0003=dddd"

Log in

"http://xxx.xxx.xxx.xxx/modify?0025=i"

Toggle manual mode

"http://xxx.xxx.xxx.xxx/modify?0003=0000"

Log out

Variables provided for communicating with the building automation system (date: 13.01.2015):

No.	Name	Read/ Write	Format	Range	Info
0003	User PIN	W	"####"	"0000" - "9999"	Login
0013	Heating status text	R	ASCII text		
0015	Filter system status text	R	ASCII text		
0025	Filter system manual operation	W	ASCII	'0', '1', 'i'	0: switch off 1: switch on i: toggle
0027	ECO mode (manual)	W	ASCII	'0', '1', 'i'	0: switch off 1: switch on i: toggle
0100	Water temperature	R	"##.#"		
0101	Solar temperature	R	"##.#"		
0102	Air temperature	R	"##.#"		
0110	Required water temperature	R/W	"##.#"	"00.1" - "40.0"	
0123	Frost protection function	W	ASCII	'0', '1', 'i'	0: switch off 1: switch on i: toggle
9000	Collective fault indicator	R	'#'	'0' - '1'	'0'=Off, '1'=On
9013	Heating status variable	R	'#'	'0' - '3'	'0'=Off '1'=heat exchanger '2'=solar heating
9019	Filter pump status variable	R	'#'	'0' - '3'	'0': pause '1': ECO speed '2': normal speed '3': high speed
9025	Manual operation status variable	R	'#'	'0' - '1'	'0'=Off, '1'=On
9027	ECO mode status	R	'#'	'0' - '1'	'0'=Off, '1'=On

Menu structure

Filter pump	ECO mode	Heating	Solar heating	Frost protection
Select menu < filter PUMP >	Select menu < ECO-mode >	Select menu < heating >	Select menu < solar heating >	Select menu < frost protect >
filter PUMP < type >	ECO-mode < timer >	heating < operation mode >	solar heating < operation mode >	frost protect < operation mode >
filter PUMP < motor current >	ECO-mode < Temp. reduct. >	heating < Priority >	solar heating < Priority sol. >	frost protect < Air temperat. >
filter PUMP < motor protect >		heating < minim.sw-time >	solar heating < minim.sw-time >	frost protect < water temp. >
filter PUMP < startup time >		heating < subseq. run >	solar heating < Solar ON dT >	
		heating < temp. limit >	solar heating < Solar OFF dT >	
			solar heating < Temp.increase >	
			solar heating < PUMP power >	
Backwashing	Level control	Auxiliary output	Network	Sensor calibration
Select menu < backwashing >	Select menu < level control >	Select menu < auxil. output >	Select menu < network (LAN) >	Select menu < Calibr.sensors >
backwashing < operation mode >	level control < type >	auxil. output < operation mode >	network (LAN) < IP-Address >	Calibr.sensors < water temp. >
backwashing < Timer >	level control < time limit >	auxil. output < Timer >	network (LAN) < Device-ID >	Calibr.sensors < solar temp. >
backwashing < Durat. backw. >	level control < minim.sw-time >	auxil. output < Cycle time >	network (LAN) < User PIN >	Calibr.sensors < Air temperat. >
backwashing < Durat. rinse. >		auxil. output < Pulse duration >	network (LAN) < Service PIN >	
backwashing < valve delay >		auxil. output < Interlocking >		
backwashing < fortnightly >				
backwashing < Floor Drain >				

Relax and enjoy your swimming pool!